

L	30	41	52	63	74	85
C	16	27	38	49	60	71

OPCJA



Kod 5090.1151



Kod 5090.1150



Kod 5090.1119

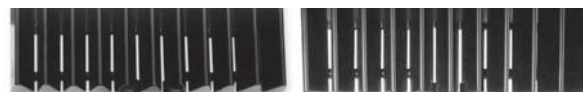

Kod 5094.425

Kod 5094.427

Kod 5090.1151

Standard

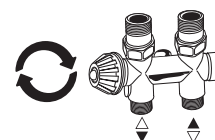
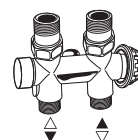

Złącza do instalacji znajdziesz w katalogu Jaga
www.jaga.com.pl

Uwaga

Aby zagwarantować moc grzejnika Jaga zaleca się stosować rurki o średnicach 16/2, 18/1, 18/2.

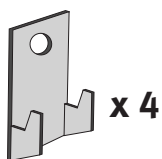

x 4



Ze względów bezpieczeństwa kotki rozporowe nie są dostarczane w komplecie. Dobierz odpowiednie kotki do swojej ściany.

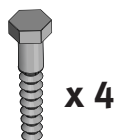

x 4

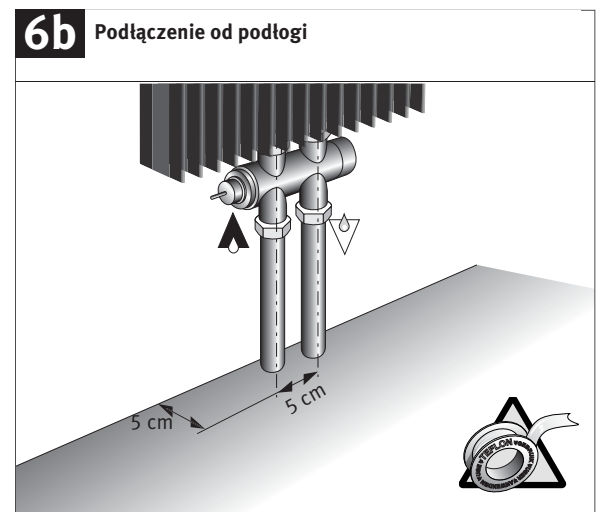
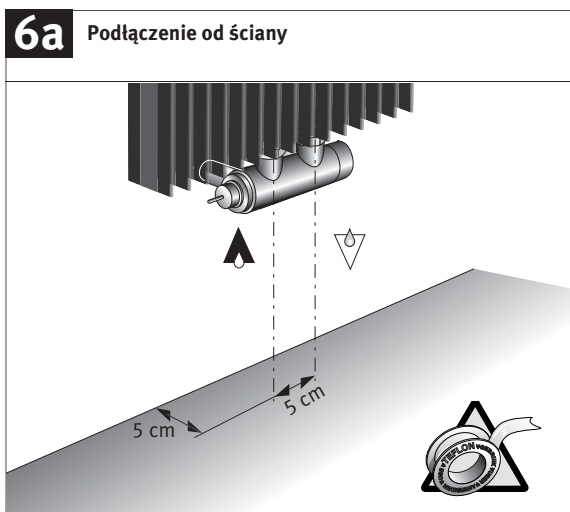
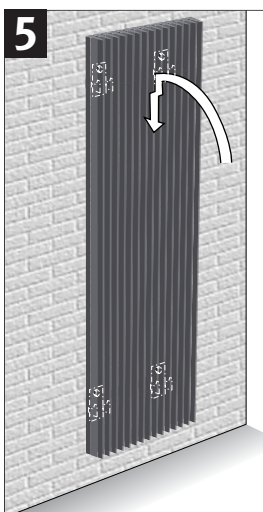
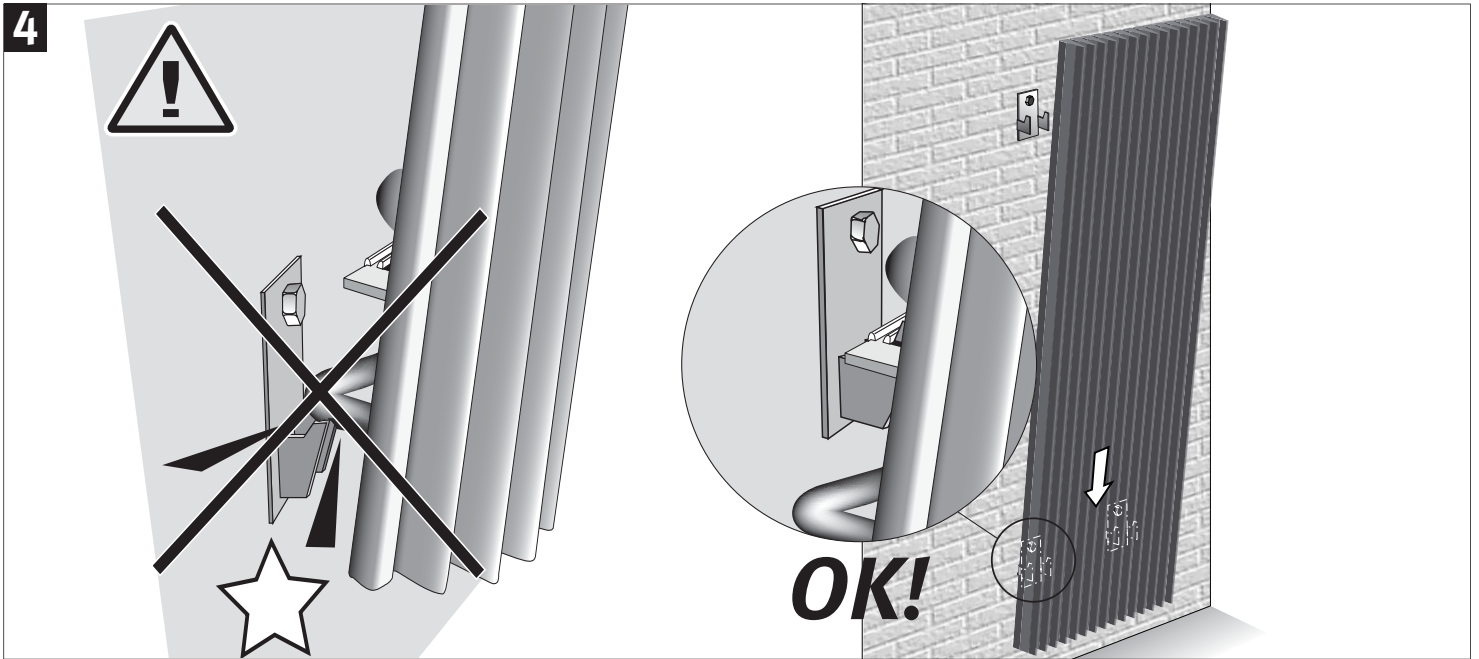
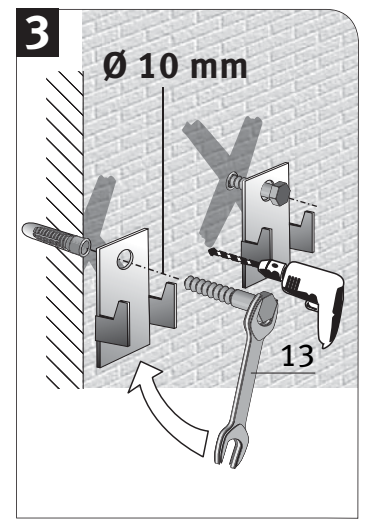
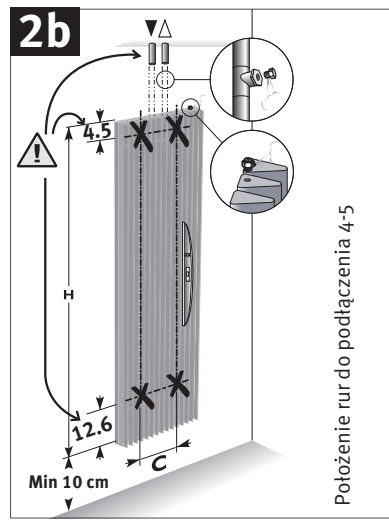
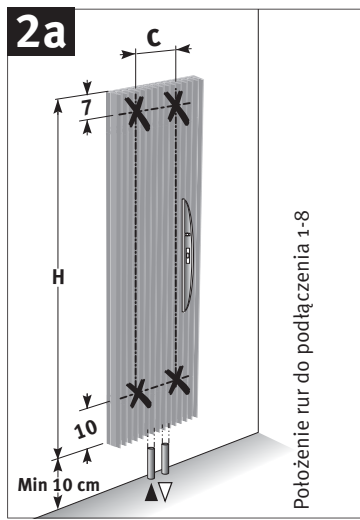
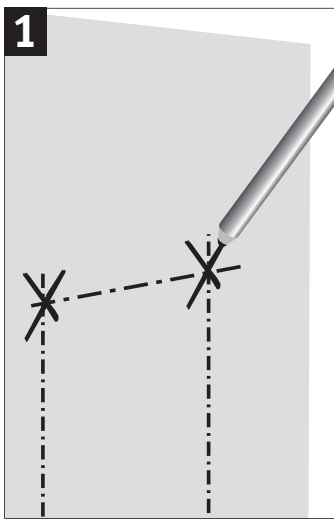

Podłączenie do instalacji jedno- lub dwu-rurowej

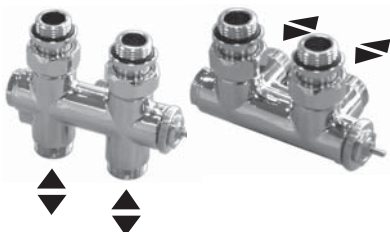

Zasilanie z prawej lub lewej strony, niezależnie od pozycji głowicy termostaticznej.

